

# INSTRUCTION FOR FLOATING CONTROL OF ELECTRICAL PUMP

The device, connected to an electrical pump through an electrical cable, is used for the auto-control and no-water protection of the water tower and water pool.

## 1. TECHNICAL DATA:

- \* Rated Voltage: AC 125V/250V
- \* Max. Current: 16(4)A
- \* Frequency: 50-60Hz
- \* Max. Operating Temperature: 50°C
- \* Protection Grade: Ip68

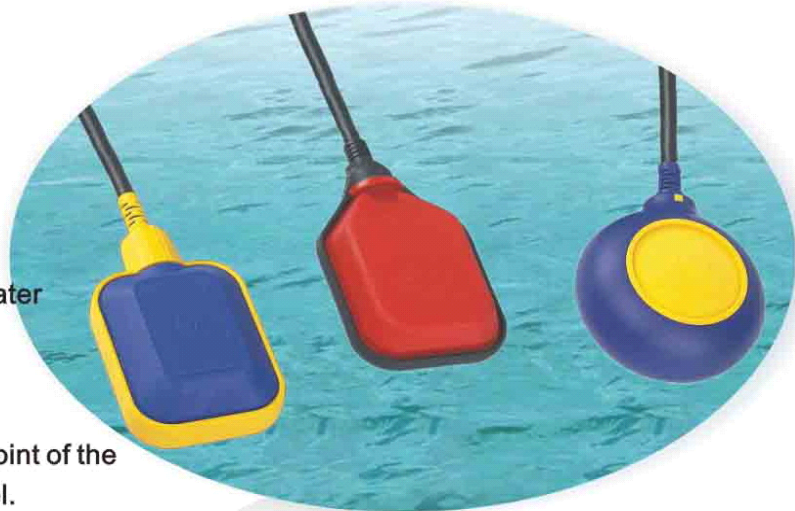

## 2. INSTALLATION:

- (1) Fix the counterweight on the power cable to control water level. (Counterweight is only provided at request.)
- (2) Connect the electrical cable with the electrical pump and then fix it inside the water tank.
- (3) The length of the cable section between the fixation point of the device and the device body determines the water level.
- (4) The terminal of the electrical cable shall never be immersed into water during installation.

## 3. INSTRUCTION FOR USAGE:

- (1) Instruction for water-filling operation:

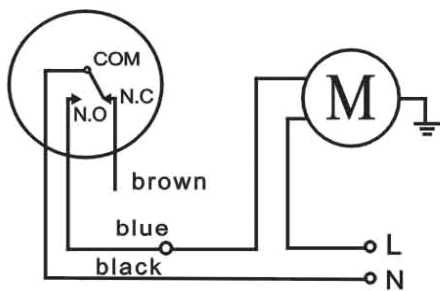

Fig1

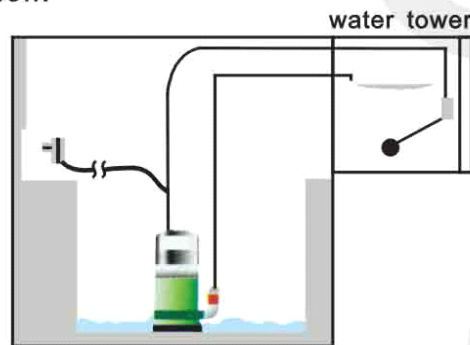

Fig2

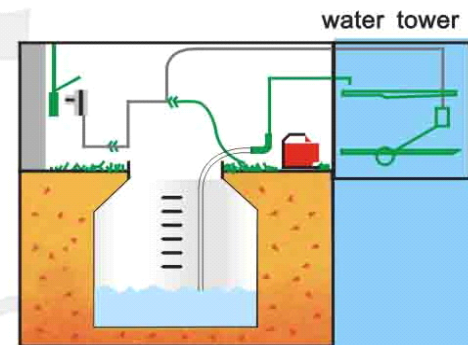

Fig3

Connect the blue cable of the floating control to the electrical pump and the black one to a neutral wire as shown in Fig.1 for water filling operation (The brown cable shall be kept insulated).

For detailed installation instruction, please refer to Fig.2 and 3.

Function of Fig2& 3: Electrical pump begins to fill water when the water in water tank drops to a certain level and stops its working then water rises to a certain level.

- (2) Instruction for water-emptying operation:

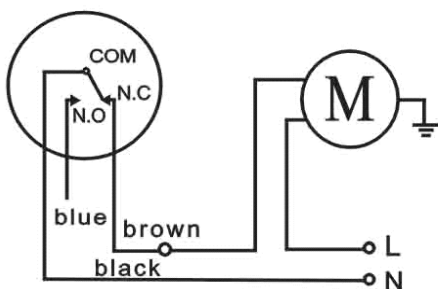

Fig4

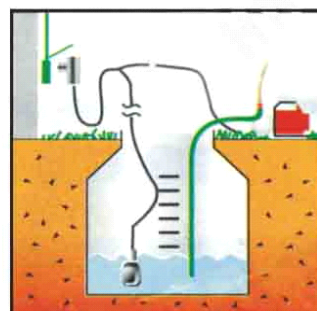

Fig5

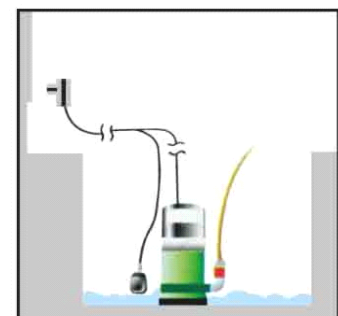

Fig6

DIRECTION FOR USE

DIRECTION FOR USE

Connect the brown cable to the water pump and the black one to a neutral wire as shown in Fig.4 for water emptying operation(The blue cable shall be kept insulated).For detailed installation instruction,please refer to Fig.5 and 6.

Function of Fig.5 & 6: Electrical pump stops when the water level in the water pool drops to a certain level and starts to empty water again when the water level increases.

#### 4.INSTRUCTION FOR AUTO-FILLING & AUTO-EMPTYING:

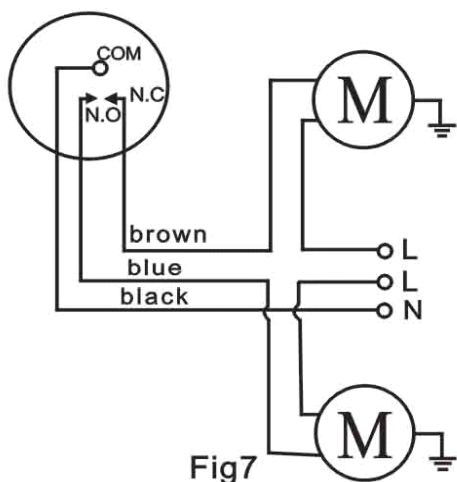

Fig.7:shows the auto -switch between filling and emptying water, which is an extension of the two basic functions.

Please refer to the two basic functions for details.

#### 5.ILLUSTRATION FOR COUNTERWEIGHT INSTALLATION:

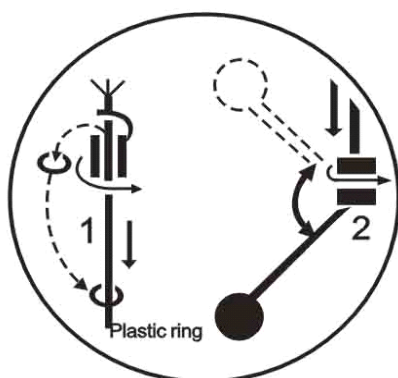

Fig.8:Peel the plastic ring off the counterweight before installation and set the ring around the cable, then insert the cable from the conical part into the counterweight and fix it with moderate pressure at the fixing end.

#### 6.WARNING:

- (1)The power supply cable is an integrate part of the device Should the cable be found to be damaged the device is to be replaced.Repairs to the cable itself are not possible.
- (2)The cable terminal must be never immersed into water.
- (3)The cable that is not used must be correctly insulated.
- (4)The electrical pump must be grounded to avoid any accidents.

#### 7.WARRANTY STATEMENT:

For any defects caused by mal-manufacture,the user can return the device to the manufacturer for repair or replacement within 6months from factory delivery. This warranty does not apply to any defects caused by misuse and improper storage.

